

Ultrasonic Ranging double integration module user's Guide

model: AJ-SRO4K-MS

Product physical map:

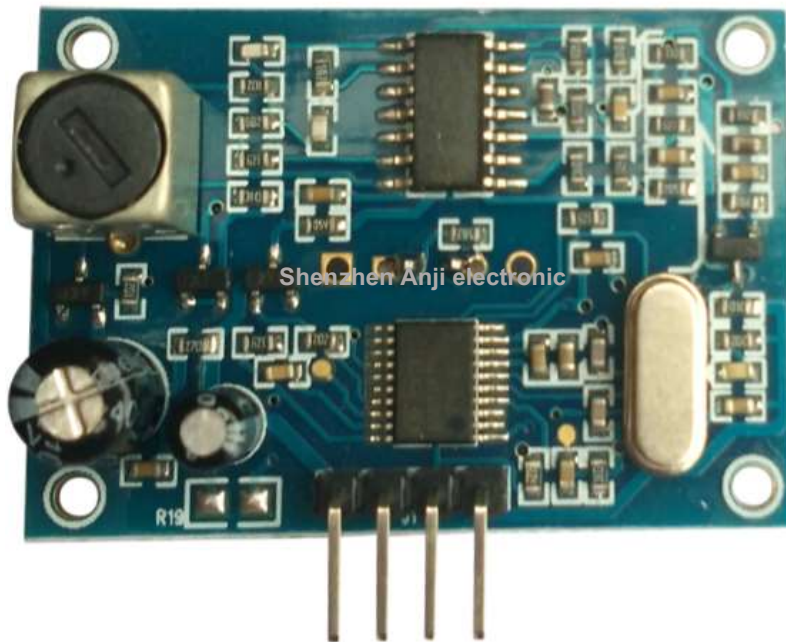
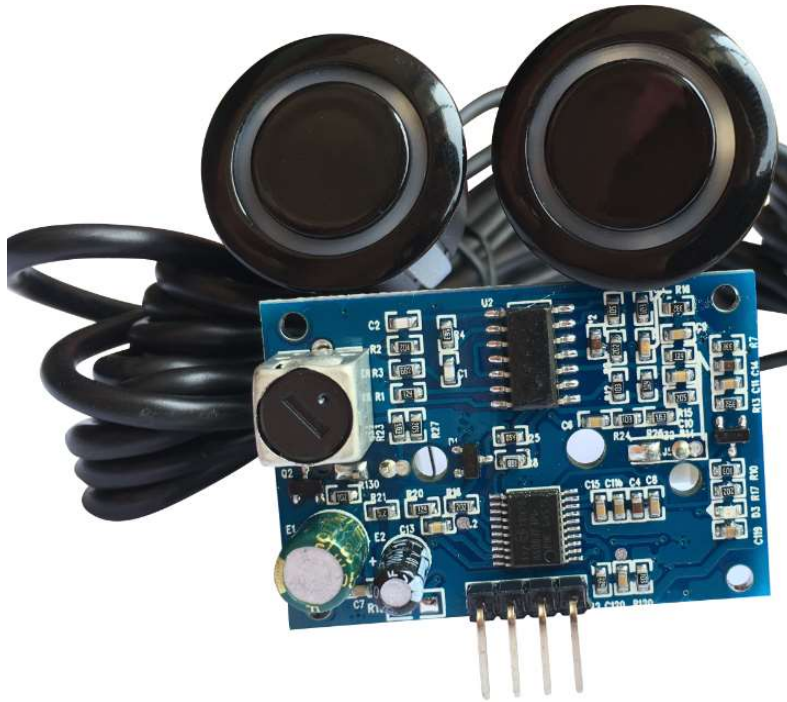

table of Contents

>> Product Overview	2
>> Features	4
>> Applications	4
>> Technical parameters	5
Product Structure	5
Electrical parameters	5
>> Output Format Description Module 6	
Mode switching method	6
Module startup process	6
Mode 1 works	7
Mode 2 works	8
Mode 3 works	9
Mode 4 works	10
Mode 5 works	11
..... operating mode switch	12

>> Installation module	13
FIG	beam angle 13
Location selection	14
I.	14
Scenario 2	14
Case of a three	15
Case of a four	15
V.	16
Human subject range	16
>> Note	17
>> Size	17
Ultrasonic transducer size 17
..... size control board	18

>> product description

AJ-SR0K- Ultrasonic Ranging TX double module, is to use a waterproof strip line transceiver probe, transport

A non-contact ultrasonic detection technology designed again. Products in the range of 5cm to 800cm, it is possible to accurately detect the distance to the object plane, and within the range of 5cm to 250cm, people can be accurately measured.

The basic working principle: Ultrasonic Ranging module is connected after this 3-5.5V power module of the present comprising five operating modes. If the relevant requirements, you can contact the company, we will provide you with customized and meet your demand for the product

- | | |
|--|----------------------------------|
| Mode 1: square wave pulse reflected | • Lowest power consumption 40uA |
| Mode 2: the pulse width of the square wave radio | • Lowest power consumption 40uA |
| Mode 3: Automatic Serial | • Lowest power consumption 2.5mA |
| Mode 4: Serial Trigger | • Lowest power consumption 20uA |
| Mode 5: ASCII code output | • Lowest power consumption 20uA |

>> Features

- 1, small size, easy to use;
- 2, low-power, low-power mode when the first Optional <20ua; 3, using the wide voltage operating voltage 3-5.5V 3, high measurement accuracy 1mm maximum resolution accuracy; 4, anti-interference;
- 5, integrated with a line probe enclosed water in the wet, poor measurement field

>> Product Applications

- 1, the smart car distance, obstacle avoidance 2, the object distance measurement, height measurement body 3, intelligent traffic control, parking control 4, teaching and research, security, industrial control 5, artificial intelligence, the aircraft altitude measurement

>> Technical Parameters:

Product Structure

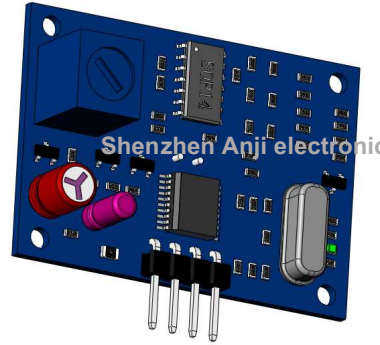
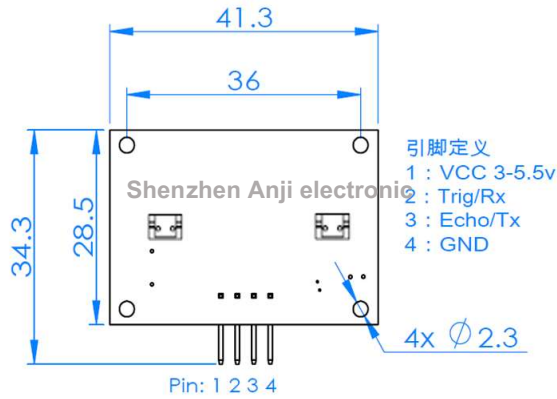

Electrical parameters

Electrical parameters	AJ-SR04K Ultrasonic module
Operating Voltage	DC 3-5.5V
Working current	40mA Duration is less than 50us
stand-by current	2mA
Low Power Current Mode 2	Electric current 40uA, mode 4,5 Electric current 20uA
working frequency	40KHz
The farthest range	8m
Recent Range	5cm
Angle measurement	75 degree
Input trigger signal 2: Trig / RX	Trigger / serial receive / enable switch
3: Echo / TX	Pulse Width / serial output / switch output
Output echo signal output	TTL, Serial ports 5 The serial output modes
selected format resolution	9600 n 8 1
	approximately 2mm
Operating temperature	--20-75 °C
storage temperature	--40-80 °C
Probe line length	1 Meter / 2.5 Meter / 6 Meter
Status Indication	led It indicates the state, a work flash once / output state of the switch
Standard sizes	41.3 * 28.5 * 23mm

>> Output Format Description Module

The method of switching mode, in case of power failure following replacement of the module above to change the resistance R19 mode

模式选择方法

1. 兼容市面HR-04触发模式
2. 低功耗模式
3. 自动串口模式
4. 低功耗串口模式
5. 电脑打印模式

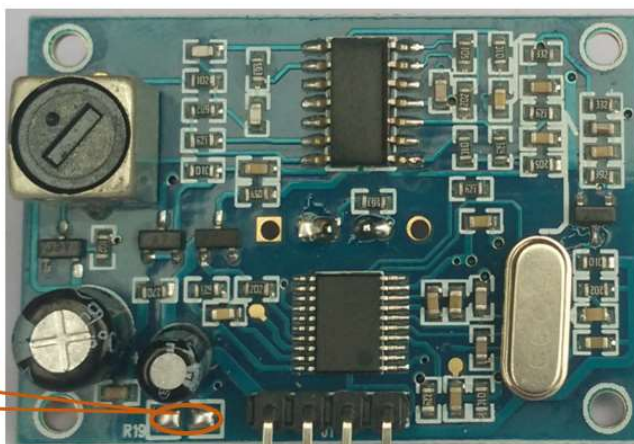

模式	模式对应R19阻值	待机电流	低功耗电流	盲区	最远距离
1:兼容SR-04模式	开路	<2ma	----	20cm	8.00米
2:低功耗SR-04模式	300KΩ	<2ma	< 40ua	20cm	8.00米
3:自动串口模式	120KΩ	<2ma	----	20cm	8.00米
4:触发串口模式	47KΩ	<2ma	< 20ua	20cm	8.00米
5:PC打印模式	0KΩ	<2ma	< 20ua	20cm	8.00米

Start flowchart module

模块工作流程图



模式1: 待机电流<2.0ma,工作电流30ma

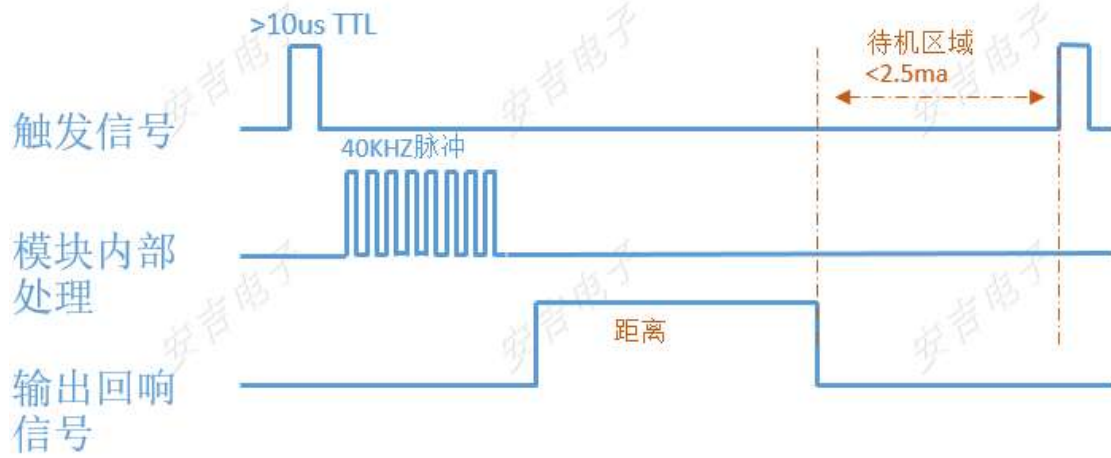

A pin definition mode: Trig • Trigger

Echo • Echo signal output

Working Mode 1: When a Trig to a high level greater than 10us trigger signal, the module will work out a corresponding Echo pin outputs a high level, the high level time is the distance of the object

Echo distance calculated by the formula: $uS / 58 = Cm$ or $uS / 148 = Inch$; or: $High\ Time * distance = velocity\ of\ sound\ (340M / S) / 2$;

mode 1 Module lowest power consumption 2.5mA

模式2: 低功耗<40ua,工作30ma

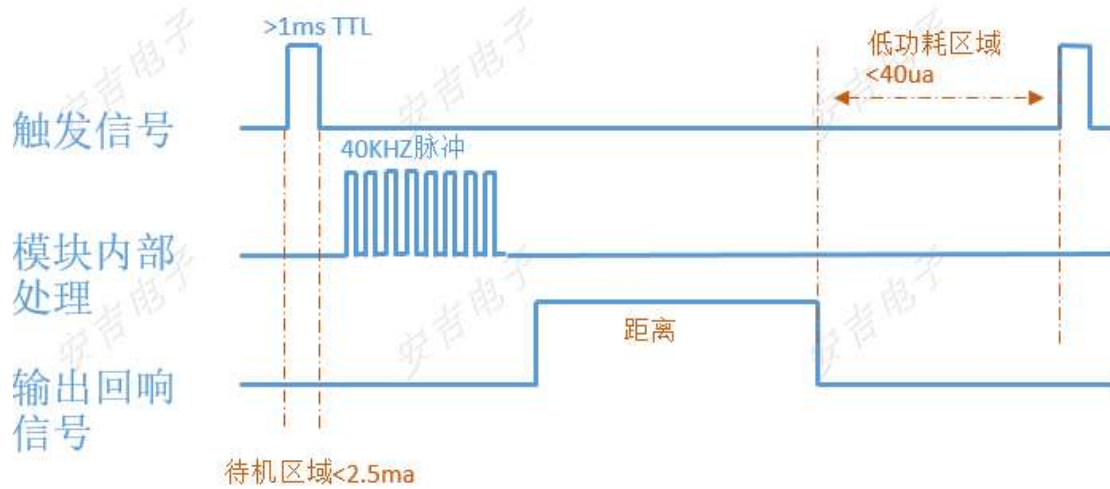

Mode 2 pin definitions: Trig • Trigger
Echo • Echo signal output

Mode 2 works: when a is greater than a Trig **1ms** High level trigger signal, the module will work out a corresponding

Echo pin will output a high level, a high level of time is the distance from the object (note Trig high time greater than 1ms to ensure the normal trigger)

Echo distance calculated by the formula: $uS / 58 = Cm$ or $uS / 148 = Inch$; or: High Time * distance = velocity of sound (340M / S) / 2;

mode 2 Module lowest power consumption 40uA

模式3: 串口自动模式, 平均电流5ma

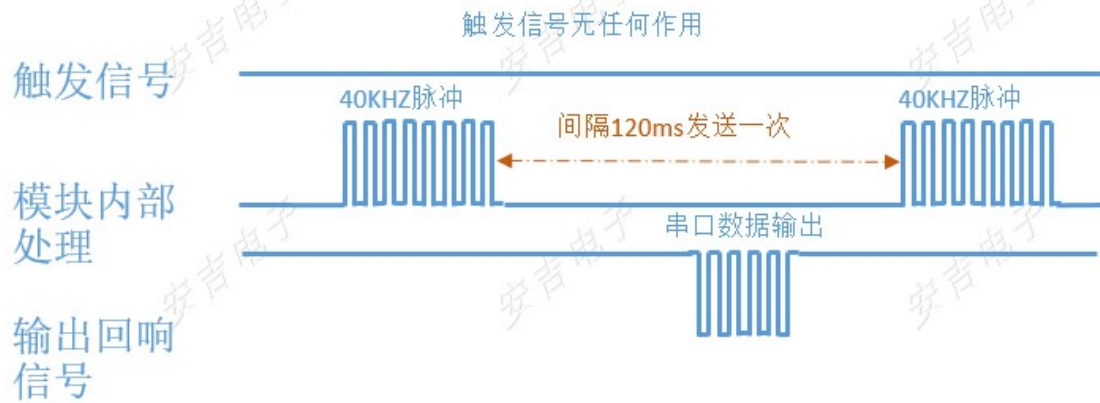

Mode 3 pin definitions: RX • No meaning

TX • Echo signal output

3 work mode: each module to automatically output a 100ms, with four 8-bit data frame format: 0XFF + H_DATA + L_DATA + SUM baud rate is set 9600, none, 8bit, 1stop 1,0XFF: as a start data for judging 2, H_DATA:... the distance data upper 8 bits 3, L_DATA: lower 8 bits from the data.

4, SUM: data and for efficacy .H_DATA + L_DATA = SUM (only the lower 8 bits) 5, H_DATA L_DATA synthesized with 16-bit data, i.e., the distance in millimeters value, for example...:

Product answer: FF 07 A1 A7

Wherein the check code SUM = A8 = (0x07 + 0xA1) & 0x00ff 0x07

distance data is high; 0xA1 is at a low distance data;

Distance value 0x07A1; is converted to decimal 1953; unit: mm

Echo distance calculated by the formula: $uS / 58 = Cm$ or $uS / 148 = Inch$; or: High Time * distance = velocity of sound (340M / S) / 2;

mode 3 Module lowest power consumption 2.5mA

模式4: 串口低功耗模式,低功耗<20ua,待机2ma

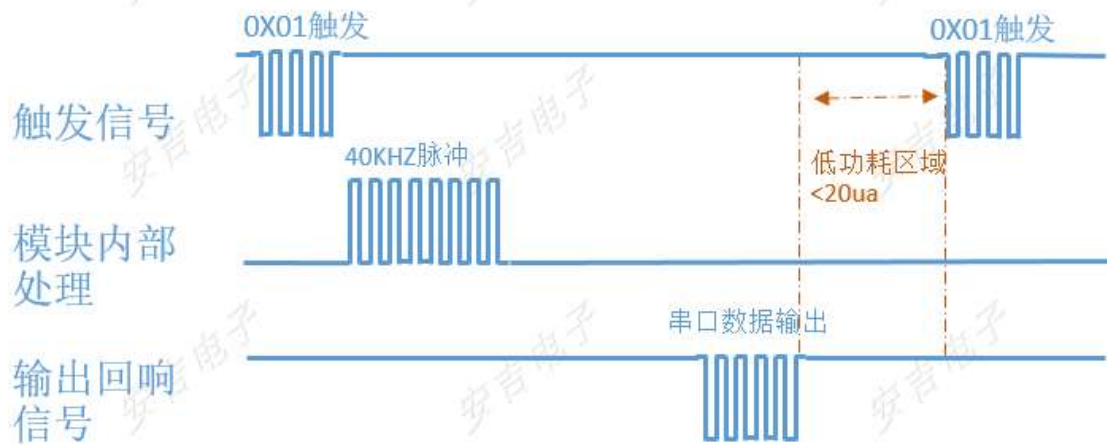

Mode 4 pin definitions: RX • Send any number of triggers once, or set to a low level will trigger a

TX • Echo signal output

Mode 4 works: a serial data to transmit the RX RX pin or pins set low again, the module outputs a distance data, comprising four 8-bit data frame format is: 0XFF + H_DATA + L_DATA + SUM , baud rate is set 9600, none, 8bit, 1stop 1,0XFF: as a start of the data, for judging 2, H_DATA:... the 8 bits of data from 3, L_DATA: lower 8 bits from the data.

4, SUM: data and for efficacy .H_DATA + L_DATA = SUM (only the lower 8 bits) 5, H_DATA L_DATA synthesized with 16-bit data, i.e., the distance in millimeters value, for example..:

Product answer: FF 07 A1 A7

Wherein the check code SUM = A8 = (0x07 + 0xA1) & 0x00ff 0x07

distance data is high; 0xA1 is at a low distance data;

Distance value 0x07A1; is converted to decimal 1953; unit: mm

Echo distance calculated by the formula: $\mu\text{S} / 58 = \text{Cm}$ or $\mu\text{S} / 148 = \text{Inch}$; or: High Time * distance = velocity of sound (340M / S) / 2;

mode 4 Module lowest power consumption 20uA

模式5: 串口低功耗模式,待机<20ua,工作30ma

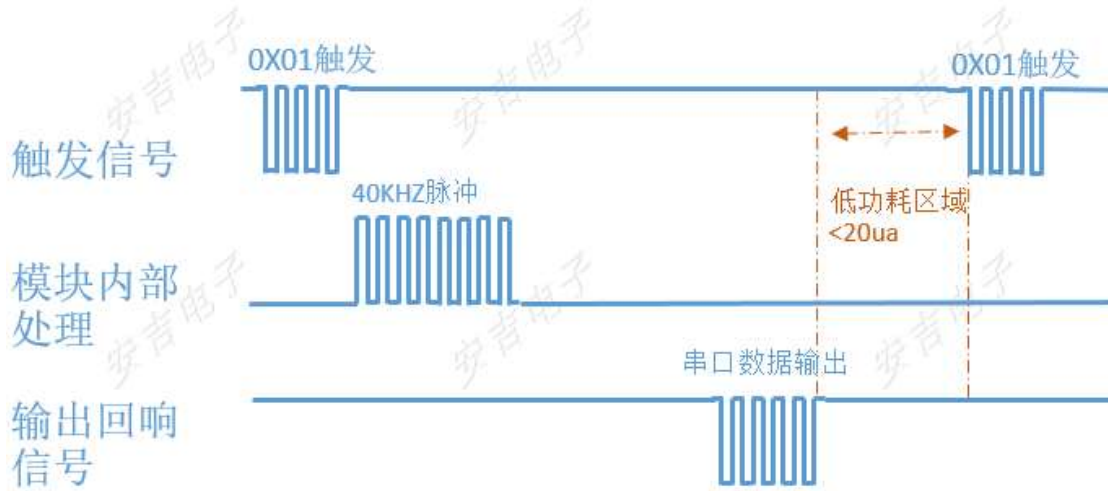

Mode 5 pin definitions: RX • Send any number of triggers once, or set to a low level will trigger a
TX • Echo signal output

Mode 5 works: a serial data transmission to the RX RX pin or the pin is set low again, the output will be a ranging data module, the data displayed in ASCII, baud rate is set 9600, none, 8bit, 1stop

mode 5 Module lowest power consumption 20uA



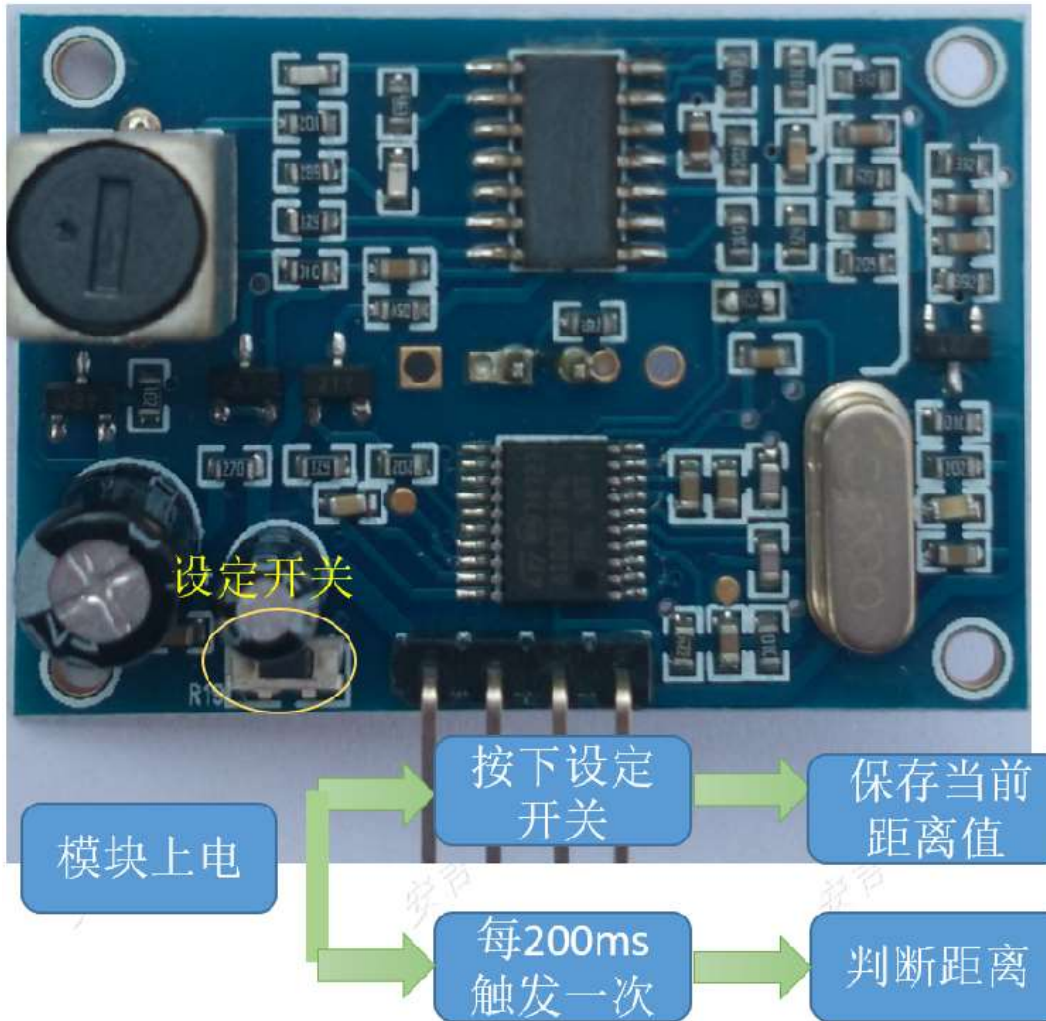

Mode switch pin definitions: Trig • The default high work pause work module is set low

Echo • Output low than the set value, less than the output high

Mode switch mode of operation: a module will automatically detect 200ms, and determines the state of high pin Trig the module as the module is a low work temporarily waiting the arrival of a high level, output low Echo than a set value, is less than how to set the output high Echo from: a: through the power module

Two: probe against objects such as walls

III: Press the "set switch" is more than 0.5, if the probe is 2 m 2 m away from the wall disposed a distance

>> DESCRIPTION OF FIG

module mounting beam angle

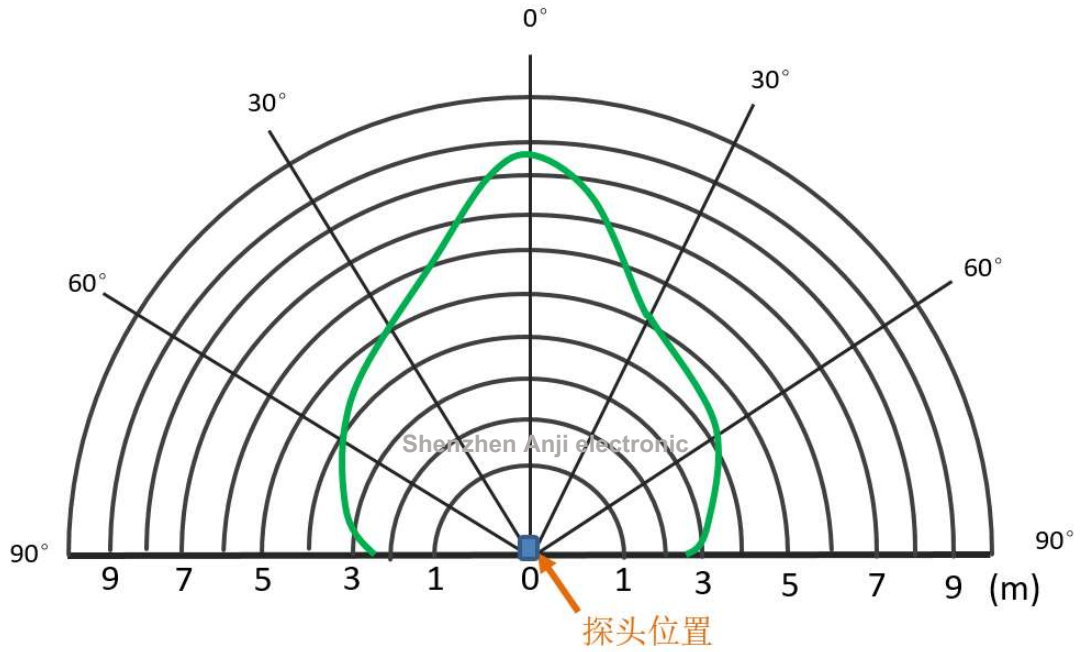

Beam angle: an ultrasonic transducer along the extended line of the central axis of the ultrasonic sensor at the time of emission (perpendicular to the sensor surface 0 Ultrasonic energy rays ° on the line) the direction of maximum. Other acoustic energy whereby outward direction gradually weakened. In the line of extension of the axis of the sensor axis, whereby the outwardly to an energy intensity is reduced by half (- 2dB) At this angle it is called beam angle.

Select Location

Requirements: the object beam angle should be within the range, as far as possible perpendicular to the axis and tangent to the arc.

Case 1:

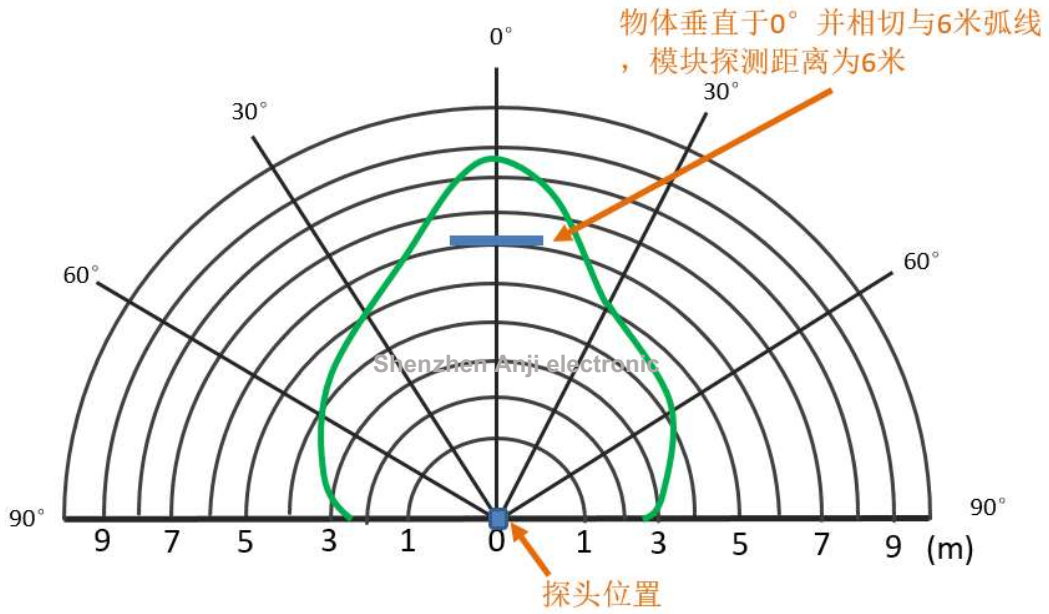

Case 2:

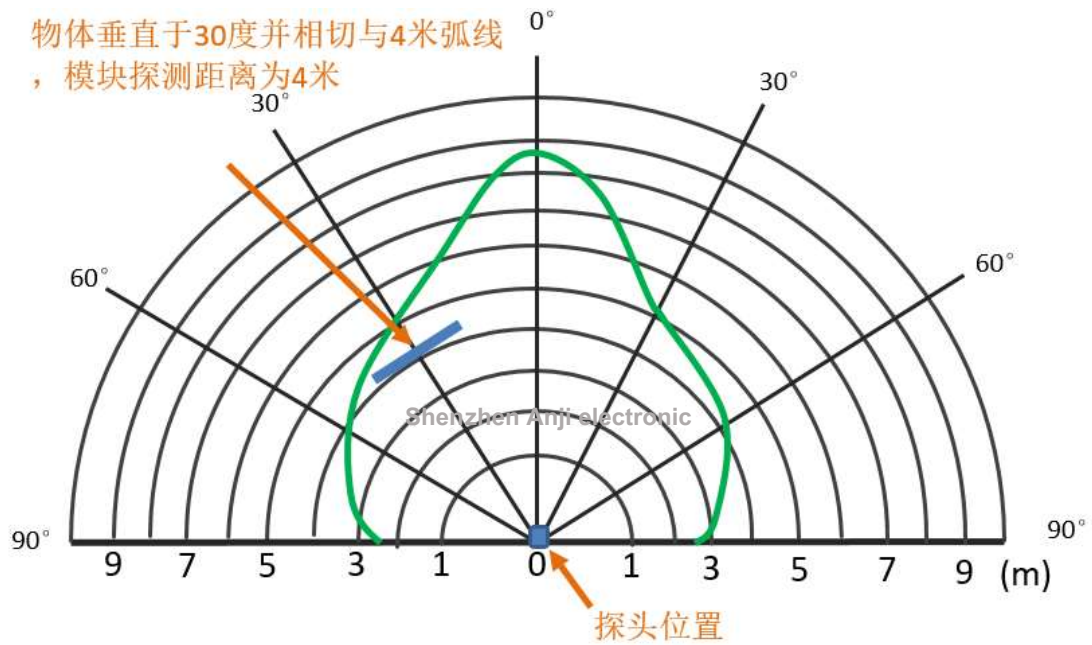

Case three:

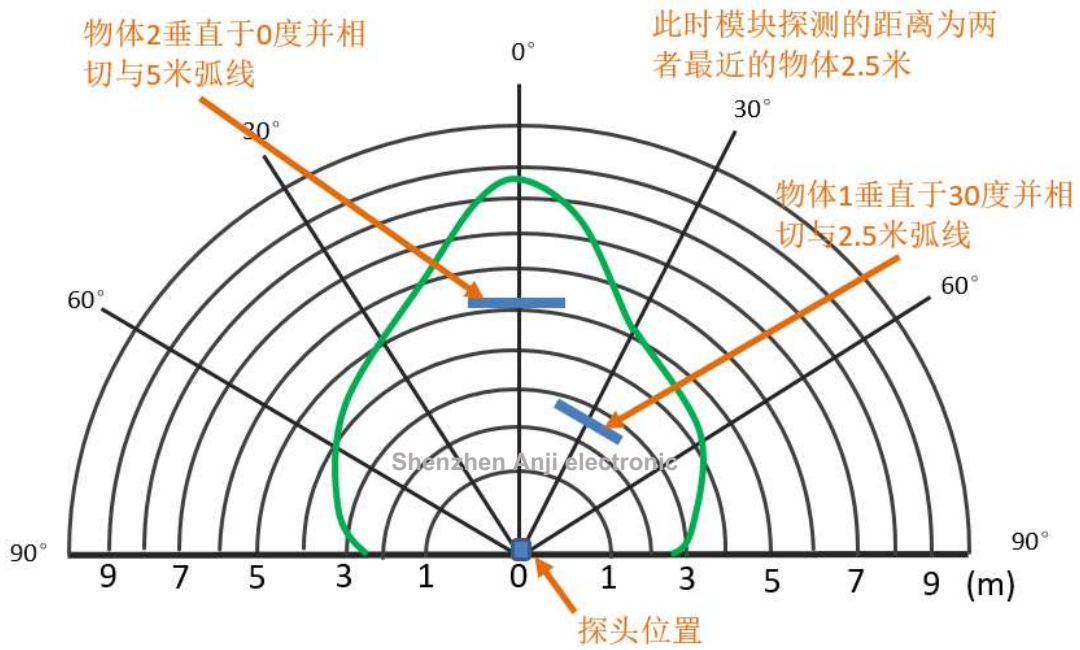

Case four:

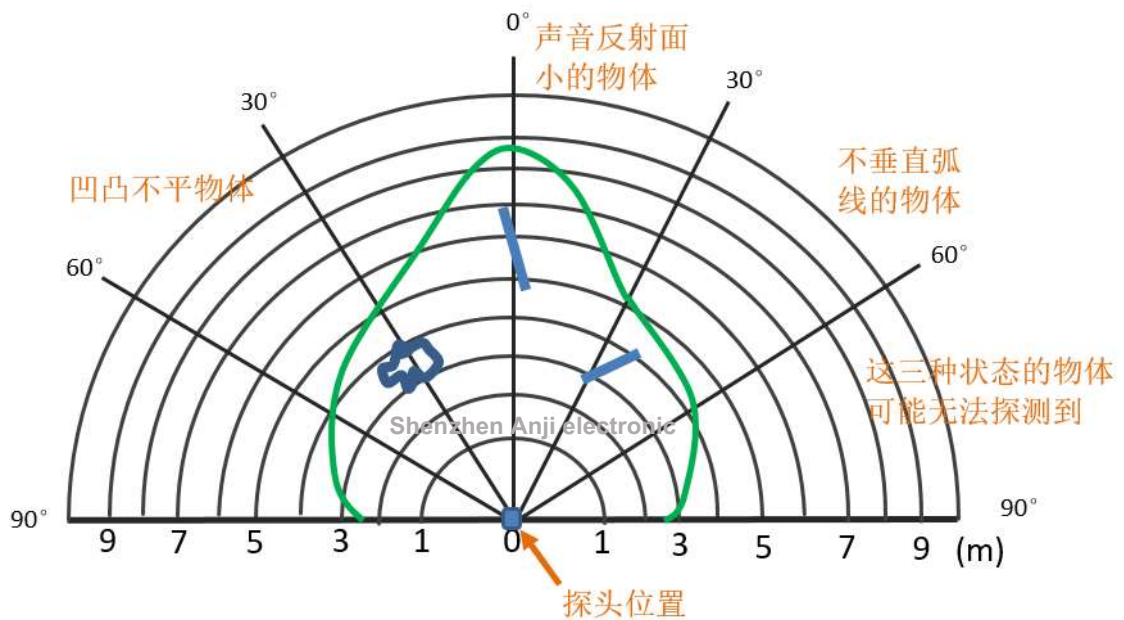

V.:

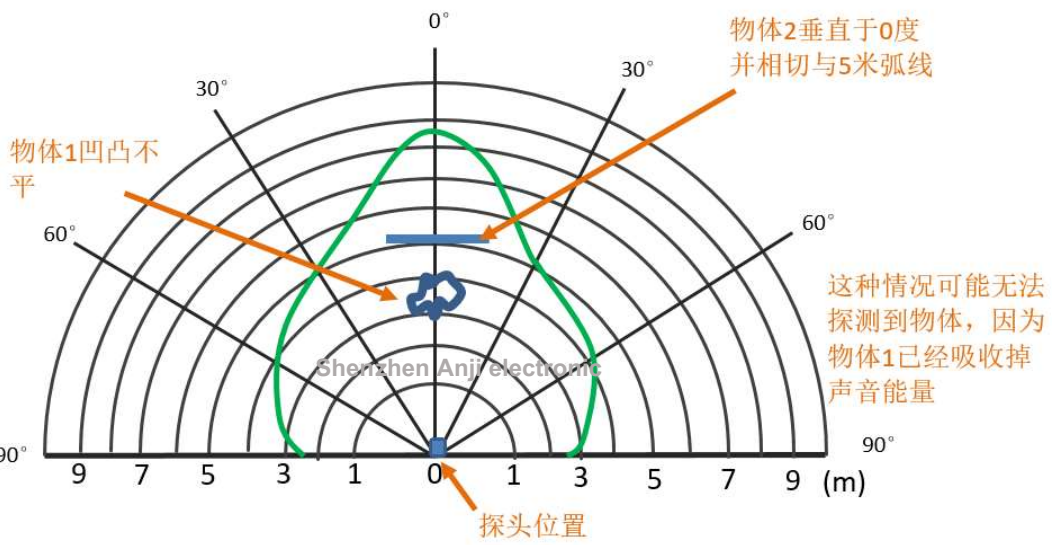

Measuring range of people

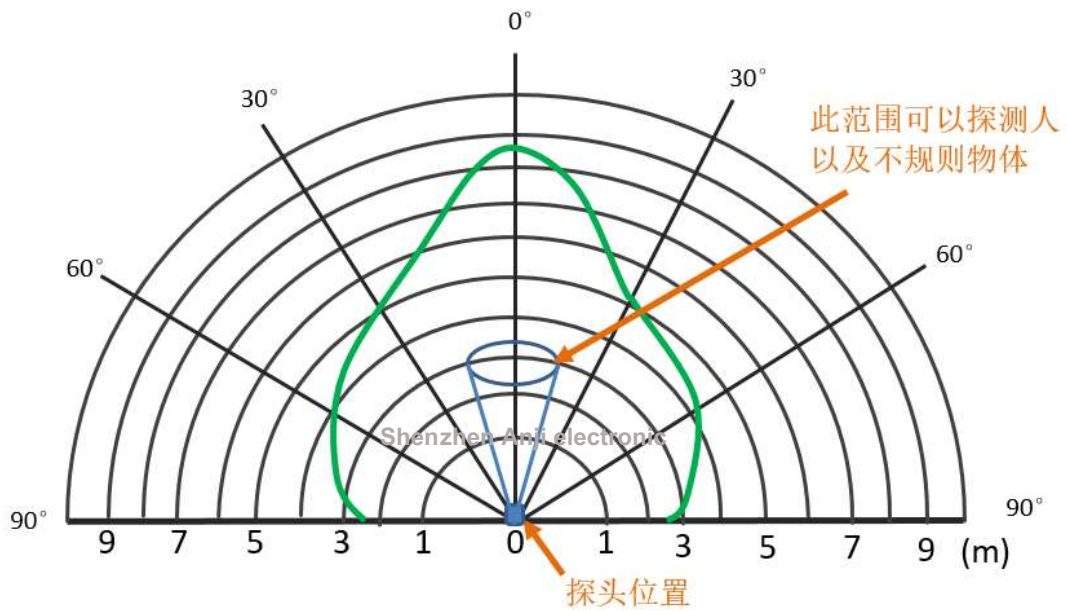

>> Precautions:

- ① Module detects a minimum distance 20cm, an object within 20cm, inaccurate signal obtained
- ② When ranging, the object area is not less than 0.2 m2 as flat and planar, otherwise it will affect

Test Results;

>> Product Size

Strip line ultrasonic transducer size

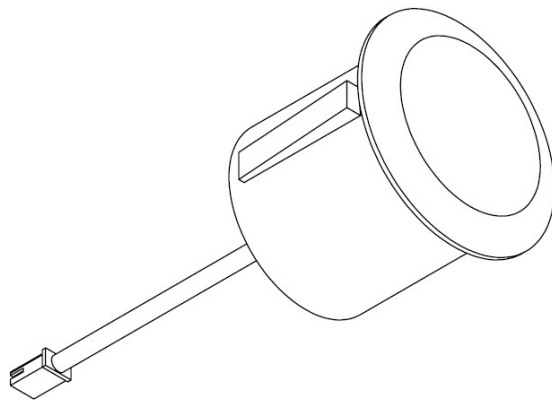
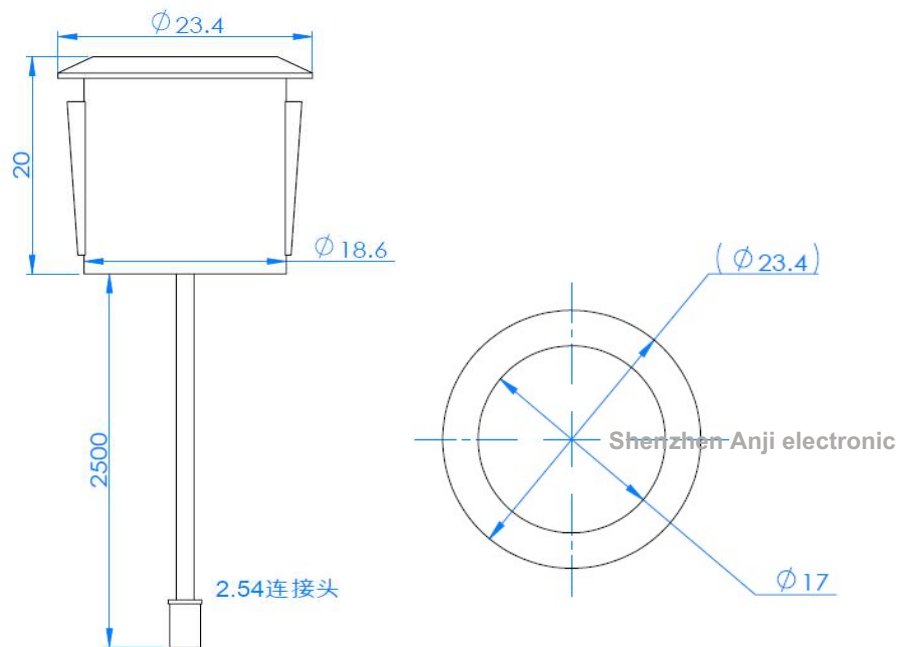

Control Board Size stripline

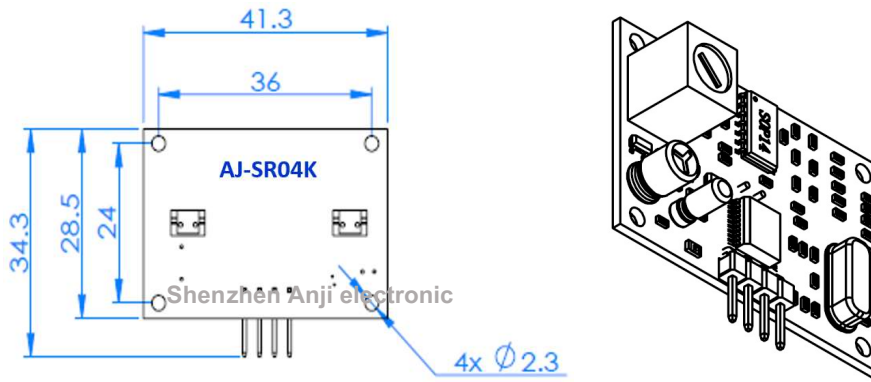
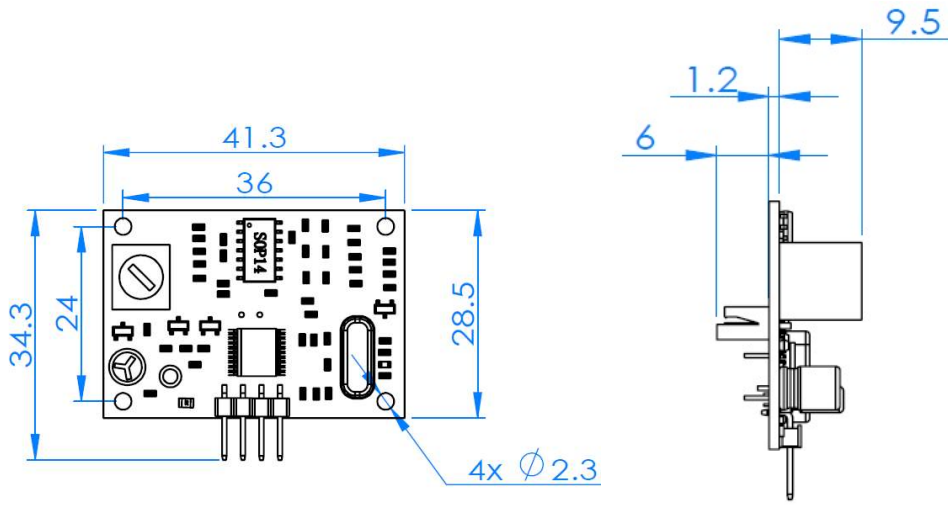

END

Thank you for reading